



Kit 78701

Tesla Model 3 AWD/RWD
REAR APPLICATION

For maximum effectiveness and safety, please read these instructions completely before proceeding with installation.

Failure to read these instructions can result in an incorrect installation which could result in damage to the vehicle, minor to severe personal injury or death.



Watch the video

Info on Table of Contents page

Protect your Air Lift Performance Purchase by Completing your Warranty Registration



Thank you for purchasing an Air Lift Performance product!

Take a photo of your sales receipt and then scan the
QR code to complete your online warranty registration.

TABLE OF CONTENTS

P.02

Introduction

- 02. Notation Explanation
-

P.03

System Overview

P.04

Installing the System

- 04. Important Safety Notices
 - 04. Section 1. Prepare the Vehicle
 - 06. Section 2. Install the Air Suspension
 - 10. Section 3. Route the Air Lines
 - 10. Finished Installation
-

P.11

Before Operating

- 11. Set the Ride Height
 - 11. Torque Specifications
 - 11. Suggested Driving Air Pressure
 - 11. Maximum Air Pressure
 - 12. Check for Binding
 - 12. Installation Checklist
 - 12. Damping Adjustment
-

P.13

Limited Warranty and Return Policy

Video-enhanced installation guides

Visit airliftcompany.com/workshop/category/install-videos to access our installation video archive*.

* subject to availability

Introduction

Air Lift Performance thanks you for purchasing the most complete, fully engineered high-performance air suspension made for the Tesla Model 3 AWD/RWD. Read these installation instructions to correctly and safely set up the vehicle for a #lifeonair.

Air Lift assumes that the installer has the mechanical knowledge and ability to work on vehicle suspension systems and has basic tools necessary to complete a suspension replacement project. Special tools needed to complete the installation are noted on the *System Overview* page.

Air Lift reserves the right to make changes and improvements to its products and publications at any time. For the latest version of this manual, contact Air Lift Performance at **(800) 248-0892** or visit **www.airliftperformance.com**.

An Air Lift Performance air management system is highly recommended for this product. Learn more at **air-lift.co/productlines**.

NOTATION EXPLANATION

Hazard notations appear in various locations in this publication. Information which is highlighted by one of these notations must be observed to help minimize risk of personal injury or possible improper installation which may render the vehicle unsafe. Notes are used to help emphasize areas of procedural importance and provide helpful suggestions. The following definitions explain the use of these notations as they appear throughout this guide.



DANGER

INDICATES IMMEDIATE HAZARDS WHICH WILL RESULT IN SEVERE PERSONAL INJURY OR DEATH.



WARNING

INDICATES HAZARDS OR UNSAFE PRACTICES WHICH COULD RESULT IN SEVERE PERSONAL INJURY OR DEATH.



CAUTION

INDICATES HAZARDS OR UNSAFE PRACTICES WHICH COULD RESULT IN DAMAGE TO THE VEHICLE OR MINOR PERSONAL INJURY.



NOTE

Used to help emphasize areas of procedural importance and provide helpful suggestions.

System Overview

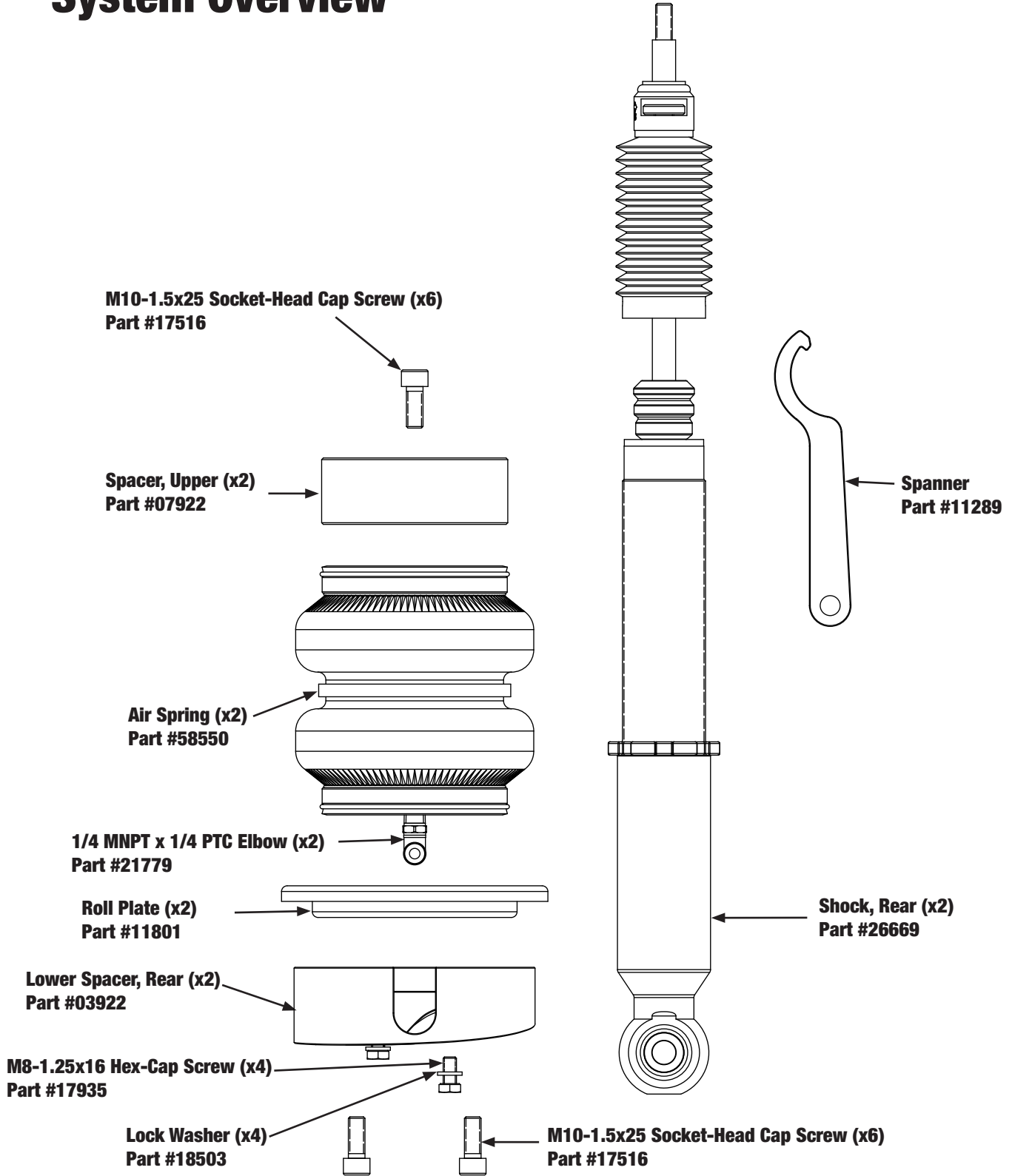

Missing or damaged parts? Call Air Lift customer service at (800) 248-0892 for a replacement part.

Installing the System

IMPORTANT SAFETY NOTICES



DO NOT INFLATE AIR SPRINGS WHILE OFF OF THE VEHICLE. DAMAGE TO ASSEMBLY MAY RESULT AND VOID WARRANTY.



DO NOT WELD TO OR MODIFY PERFORMANCE STRUTS/SHOCKS IN ANY WAY. DAMAGE TO UNIT MAY OCCUR AND WILL VOID WARRANTY.



AFTER INSTALLATION, ENSURE ALL ORIGINAL EQUIPMENT VEHICLE SAFETY FEATURES ARE PROPERLY CALIBRATED BY A QUALIFIED TECHNICIAN. CHANGING VEHICLE HEIGHT MAY AFFECT FUNCTIONING OF SAFETY SENSORS AND CAMERAS.

SECTION 1.

PREPARE THE VEHICLE



RAISE THE REAR OF THE VEHICLE WITH A JACK AT THE APPROVED LIFTING POINTS AND USE SAFETY STANDS TO SUPPORT THE VEHICLE.

1. Raise the vehicle and support with safety stands. Remove the rear wheel.



2. Remove the lower control arm and the rear drive unit protective covers.



- Loosen, but do not remove, the lower control arm inner pivot bolt.



- Support the lower control arm with a jack. Loosen and remove the lower rear shock mount bolt and lower control arm outer pivot bolt.



- Lower the jack to release the spring tension. Remove the rear spring and isolators from the vehicle.



6. Loosen and remove the upper shock mount bolts and remove the shock from the vehicle.

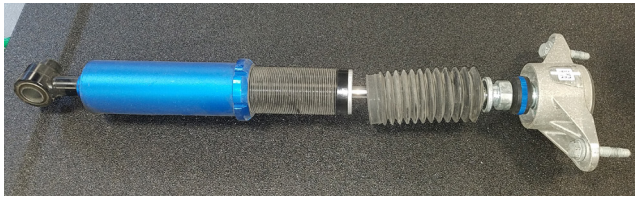
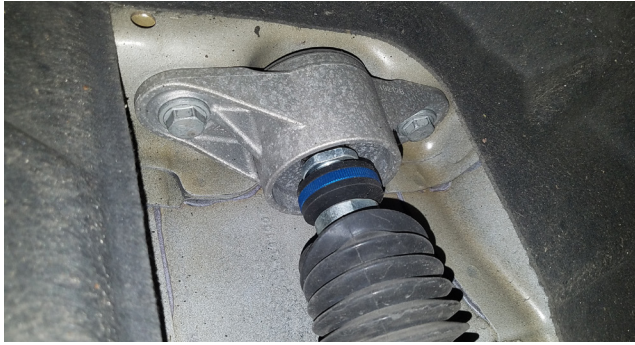

7. Remove the upper shock mount dust cap then loosen and remove the upper shock mount nut. Remove the upper mount from the shock. Do not discard the nut.

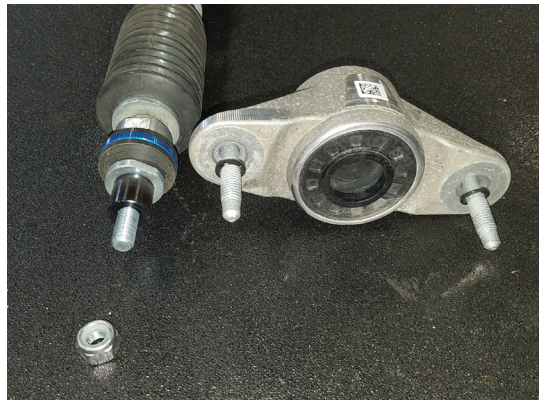

SECTION 2.

INSTALL THE AIR SUSPENSION

1. Install the upper shock mount on the Air Lift Performance shock with the previously removed nut. Torque the nut to 20Nm (15 lb.-ft.). Reinstall the upper mount dust cap.

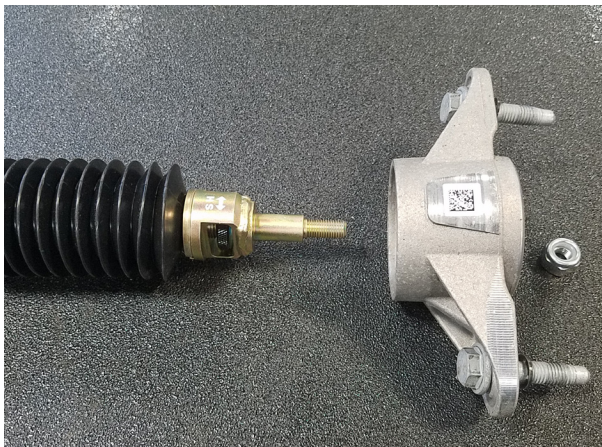

2. Install the fitting (see fitting install information) and the roll plate on the air spring.



3. Install the lower air spring spacer with the included M10 bolts. Torque the lower air spring spacer bolts to 55Nm (40 lb.-ft.).

NOTE *Ensure fitting is pointed outward (as shown) before installing the lower air spring spacer.*



4. Route the air line from the inner pivot point through the lower control arm at this time. Keep air line away from sharp corners and kinking.

5. Place the air spring in the lower control arm, making sure to align the shape of the lower spacer with the features of the lower control arm. Be sure to align the threaded mounting holes in the lower spacer with the holes in the lower control arm.



6. Install the included M8 bolts and split lock washers through the control arm to the air spring lower spacer. Torque the bolts to 25Nm (18 lb.-ft.).



7. Insert the upper shock mount into the chassis and install the bolts. Torque the bolts to 41Nm (30 lb.-ft.).



8. Raise the lower control arm with the jack while aligning the holes for the lower shock mount and lower control arm outer pivot. Reinstall the bolts and torque the control arm outer pivot bolt to 115Nm (85 lb.-ft.). Do not torque the lower shock mount bolt at this time.

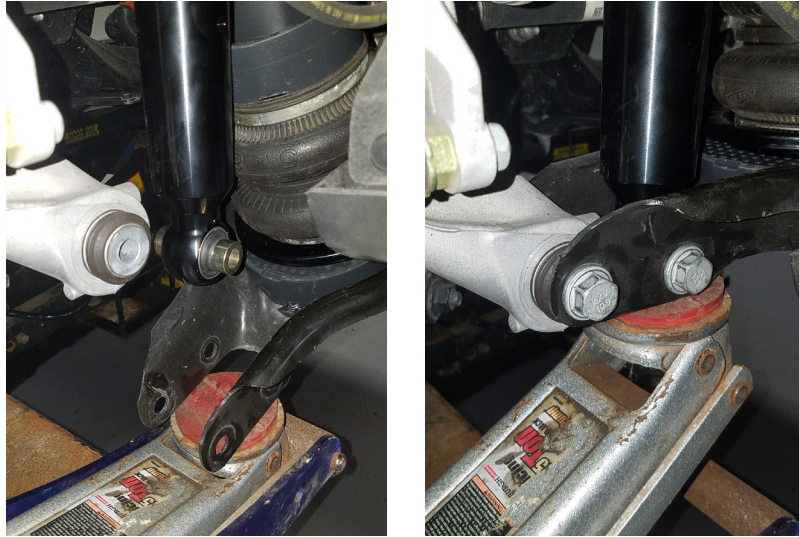

9. Reinstall the lower control arm and rear drive unit protective covers. Torque the bolts for the lower control arm cover to 6Nm (4.5 lb.-ft.) and the bolts for the rear drive unit cover to 4Nm (3 lb.-ft.)



10. Slowly inflate the air spring to at least 50 PSI while guiding the upper air spring spacer to the chassis. This will ensure that the air spring is properly seated against the chassis.

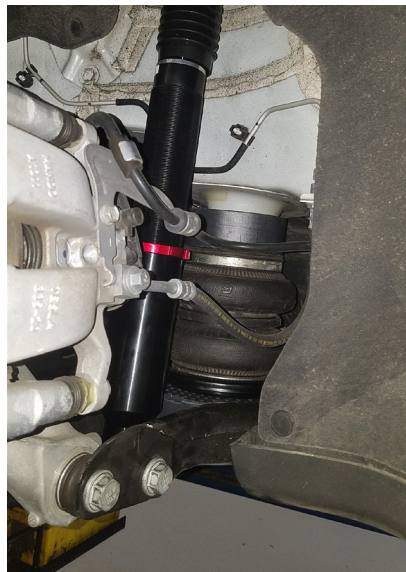

SECTION 3. ROUTE THE AIR LINES



AFTER INSTALLATION, ENSURE ALL ORIGINAL EQUIPMENT VEHICLE SAFETY FEATURES ARE PROPERLY CALIBRATED BY A QUALIFIED TECHNICIAN. CHANGING VEHICLE HEIGHT MAY AFFECT FUNCTIONING OF SAFETY SENSORS AND CAMERAS.

1. Fully compress the suspension using a jack. With the suspension compressed, review the best routing for the air line that is clear of all suspension and steering components.
2. Routing should allow for the suspension to extend and steer without kinking, pulling the line tight or rubbing on other components. Following the brake line routing is often a good place to start. Check clearances to all other components.

Finished Installation



Congratulations!

You are now the proud owner of an industry leading Air Lift Performance air suspension system. Enjoy!

Before Operating

SET THE RIDE HEIGHT

1. Refer to the User Guide supplied with this kit to set up the suspension.

Torque Specifications		
Location	Nm	lb.-ft.
Upper shock mount nut	20	15
Lower air spring spacer to air spring bolts	55	40
Lower air spring spacer to control arm bolts	25	18
Upper shock mount bolts	41	30
Lower shock mount to lower control arm bolt	115	85
Lower control arm outer pivot bolt	115	85
Lower control arm inner pivot bolt	115	85
Lower fore link to subframe bolt	76	56
Lower fore link to knuckle bolt	76	56
Toe link to subframe bolt	85	62
Toe link to knuckle bolt	76	56
Upper fore link to subframe bolt	76	56
Upper fore link to knuckle bolt	76	56
Upper aft link to subframe bolt	134	98
Upper aft link to knuckle bolt	134	98

2. Upon successful completion of the installation, follow these pressure requirements for the air springs.



Suggested Driving Air Pressure



Maximum Air Pressure



FAILURE TO MAINTAIN ADEQUATE MINIMUM PRESSURE (OR PRESSURE PROPORTIONAL TO LOAD) MAY RESULT IN EXCESSIVE BOTTOMING OUT AND **WILL VOID THE WARRANTY.**

CHECK FOR BINDING



MAKE SURE THE FRONT WHEELS ARE STRAIGHT WHEN DEFLATING AND REINFLATING AIR SPRINGS.

1. Inflate and deflate the system (do not exceed 125 PSI [8.6BAR]) to check for clearance or binding issues. With the air springs deflated, check clearances on everything so as not to pinch brake lines, vent tubes, etc. Clear lines if necessary.
2. Inflate the air springs to 75-90 PSI (5.2-6.2BAR) and check all connections for leaks.

INSTALLATION CHECKLIST

- Clearance** — Inflate the air springs to 75-90 PSI (5.2-6.2BAR) and make sure there is at least 1/2" (13mm) clearance from anything that might rub against the air spring. This should be checked with the air spring fully inflated and fully deflated.
- Leak** — Inflate the air springs to 75-90 PSI (5.2-6.2BAR) and check all connections for leaks. All leaks must be eliminated before the vehicle is road tested.
- Heat** — Be sure there is sufficient clearance from heat sources, at least 6" (152mm) from air springs and air lines. If a heat shield was included in the kit, install it. If there is no heat shield, but one is required, call Air Lift customer service at **(800) 248-0892**.
- Fastener** — Recheck all bolts for proper torque.
- Road** — Inflate the air springs to recommended driving pressures (see previous page). Drive the vehicle 10 miles (16km) and recheck for clearance, loose fasteners and air leaks.
- Operating instructions** — If professionally installed, the installer should review the operating instructions with the owner. Be sure to provide the owner with all paperwork that came with the kit.

DAMPING ADJUSTMENT

1. The dampers in this kit have 30 settings, or "clicks," of adjustable compression and rebound damping characteristics. Damping is changed through the damper rod using the supplied adjuster (example shown here) or a 3mm hex key (not included).

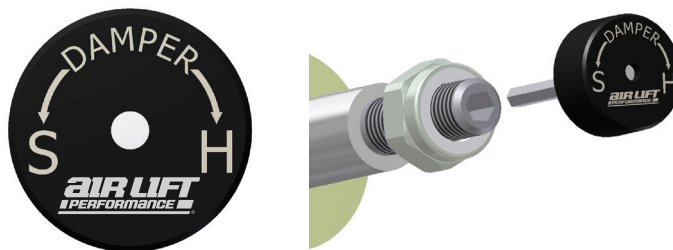

2. Turn the adjuster clockwise (H) and the damping settings are hardened, reducing oscillations and body motion. Turn the adjuster counterclockwise (S) and the damping is softened.
3. Each damper in this kit is preset to "-18 clicks." This means that the damper is adjusted 18 clicks away from full stiff, which starts at 0. Counting up from full stiff is the preferred method of keeping track of, or setting, damping. This setting was developed on a 2020 Tesla Model 3 Dual Motor.

For more information, refer to the User Guide.

Limited Warranty and Return Policy

Air Lift Company provides a 1-year limited warranty to the original purchaser of Air Lift Performance damper kits from the date of original purchase, that the products will be free from defects in workmanship and materials when used on vehicles as specified by Air Lift Company and under normal operating conditions, subject to the requirements and exclusions set forth in the full Limited Warranty and Return Policy that is available online at www.airliftperformance.com/warranty.

For additional warranty information contact Air Lift Company customer service.

Thank you for purchasing Air Lift Performance products!

Need Help?

The Air Lift Company customer service department is open from 8 a.m. to 8 p.m. ET Monday through Friday. Call (800) 248-0892 or (517) 322-2144 for calls from outside the U.S. and Canada.



CONNECT BY SEARCHING FOR **AIR LIFT PERFORMANCE** #LIFEONAIR

AIR LIFT
PERFORMANCE

2727 Snow Road Lansing, MI 48917 or P.O. Box 80167 Lansing, MI 48908-0167
Toll Free (800) 248-0892 • Local (517) 322-2144 • Fax (517) 322-0240
www.airliftperformance.com



MADE IN USA
WITH GLOBAL
COMPONENTS

Air Lift Company reserves the right to make changes and improvements to its products and publications at any time. For the latest version of this manual, contact Air Lift Company at (800) 248-0892 or visit airliftperformance.com.